



- Level monitoring relays for electrically conductive liquids
- Modular and plug-in versions
- Adjustable 2.5...200kΩ sensitivity
- Single and three-pole probes
- Float switches
- Start-up priority change relays.

	SEC. - PAGE
Level monitoring relays	
Modular version for conductive liquids	20 - 3
Plug-in version for conductive liquids	20 - 5
Probes, electrode holders and electrodes	20 - 6
Float switches	20 - 7
Float switches for grey water	20 - 7
Float switches for drinking water	20 - 8
Float switches for dirty water	20 - 8
Start-up priority change relays	
Modular version	20 - 9
Plug-in version	20 - 9
Accessories	20 - 9
Dimensions	20 - 10
Wiring diagrams	20 - 11
Technical characteristics	20 - 14



Page 20-3

LEVEL CONTROL RELAYS

- For conductive liquids
- Single, dual or multivoltage
- Emptying or filling functions
- Multifunctions
- Automatic reset
- Modular and plug-in versions.



Page 20-6

PROBES, ELECTRODES AND ELECTRODE HOLDERS

- Single pole
- Three pole.



Page 20-7

FLOAT SWITCHES

- Versions for grey water, drinking water and dirty water
- Versions with PVC and Neoprene cable
- Emptying or filling functions.



Page 20-9

START-UP PRIORITY CHANGE RELAYS

- 2 outputs
- Single or multivoltage
- Modular and plug-in versions.



LEVEL CONTROL RELAYS

START-UP PRIORITY CHANGE RELAYS FOR 2 MOTORS

Description	LVM20	LVM25	LVM30	LVM40	LV1E	LV2E	LVMP05	LVMP10	CSP2E
Modular version	●(2U)	●(1U)	●(3U)	●(3U)			●(1U)	●(3U)	
Plug-in version					● (8 pin)	● (11 pin)			● (11 pin)
3 detecting electrodes (MIN, MAX and COM)	●	●	●		●	●			
5 detecting electrodes (MIN1, MAX1, MIN2, MAX2 and COM)				●					
Sensitivity adjustment 2.5...50kΩ	●		●						
Sensitivity adjustment 2.5...100kΩ		●							
Sensitivity adjustment 2.5...200kΩ				●					
Fixed sensitivity: 7...8kΩ					●	●			
Adjustable sensitivity full-scale value 25-50-100-200 kΩ				●					
Separate sensitivity adjustment for MAX probe (foam detection)				●					
Emptying function	●	●	●	●	●	●			
Filling function		●	●	●					
Emptying function with MIN and/or MAX alarm				●					
Filling function with MIN and/or MAX alarm				●					
Emptying function with pump priority change				●					
Filling function with pump priority change				●					
Tank filling, well drawing functions and alarm				●					
Filling-emptying adjustment selector		●	●						
Programming selector for 5 different functions				●					
Motor start-up priority change							●		
Motor start-up priority change with stand-by motor function								●	●
Page	20-3			20-4	20-5		20-9		



Some permitted liquid substances

Liquid substances not permitted

Type of liquid	Resistivity kΩcm	Type of liquid	Resistivity kΩcm	<ul style="list-style-type: none"> • Purified water • Deionised water • Petrol • Oil • Liquid gases • Paraffin • Ethylene glycol • Paints • Liquids with a high percentage of alcohol
Drinking water	5...10	Milk	~1	
Well water	2...5	Whey	~1	
River water	2...15	Fruit juices	~1	
Rainwater	15...25	Vegetable juices	~1	
Sludge	0.5...2	Soups	~1	
Seawater	~0.03	Wine	~2.2	
Salt water	~2.2	Beer	~2.2	
Natural/hard water	~5	Coffee	~2.2	
Chlorinated water	~5	Suds	~18	
Condensed water	~18			

N.B. The resistivity values in the table are purely indicative.

20 Level controls

Level control relays.
Modular version

Single-voltage relay



LVM20...

Order code	Auxiliary supply voltage	Type of output contact	Qty per pack	Wt
	[V] 50/60Hz	$\frac{C}{O}$	n°	[kg]

Emptying function.
Automatic reset.

LVM20A024	24VAC	1 C/O (SPDT)	1	0.215
LVM20A127	110...127VAC	1 C/O (SPDT)	1	0.215
LVM20A240	220...240VAC	1 C/O (SPDT)	1	0.215
LVM20A415	380...415VAC	1 C/O (SPDT)	1	0.215

Operational characteristics

- Used with 3 sensing electrodes, MIN, MAX and COM
- 2.5...50k Ω adjustable sensitivity
- Double insulation between each supply, electrodes and output relay circuits
- Fixed probe signal delay: <1s
- Green LED indicator for power on
- Red LED indicator for output relay state
- Modular DIN 43880 housing (2 modules)
- IEC degree of protection: IP40 on front (only when mounted in housing or electric board with IP40); IP20 on terminals.

Certifications and compliance

Certifications obtained: UL Listed, EAC, for USA and Canada (cULus-File E93601), as Auxiliary Devices - Level control relays.

Compliant with standards: IEC/EN/BS 60255-27, IEC/EN/BS 61000-6-2, IEC/EN/BS 61000-6-3, UL508, CSA C22.2 no. 14.

Probes and electrode holders

Use probes and electrode holders type:

11SN1/31PS31/31PS3S/31SCM/31CGL or similar (see page 20-6).

Multi-voltage relay



LVM25240

Order code	Auxiliary supply voltage	Type of output contact	Qty per pack	Wt
	[V] 50/60Hz	$\frac{C}{O}$	n°	[kg]

Emptying or filling functions.
Automatic reset.

LVM25240	24...240VAC/DC	1 C/O (SPDT)	1	0.095
----------	----------------	--------------	---	-------

Order code	Description	Qty per pack	Wt
		n°	[kg]

Level control relay LVM25 240 and SN1 electrodes kit.

LVMKIT25	Level control relay LVM25240 and two 11SN1 probes	1	0.192
----------	---	---	-------



LVMKIT25

Operational characteristics

- Used with 3 sensing electrodes, MIN, MAX and COM
- 2.5...100k Ω adjustable sensitivity
- Insensitivity to stray electrode-cable capacitance
- Programming selector for emptying or filling function with fail-safe operation
- Double insulation between each supply, electrodes and output relay circuits
- Fixed probe signal delay: <1s
- Green LED indicator for power on
- Red LED indicator for output relay state
- Modular DIN 43880 housing (1 module)
- IEC degree of protection: IP40 on front (only when mounted in housing or electric board with IP40); IP20 on terminals.

Certifications and compliance

Certifications obtained: UL Listed, for USA and Canada (cULus-File E93601), as Auxiliary Devices - Level control relays, EAC.

Compliant with standards: IEC/EN/BS 60255-27, IEC/EN/BS 60255-26, UL508, CSA C22.2 n° 14.

Probes and electrode holders

Use probes and electrode holders type:

11SN1/31PS31/31PS3S/31SCM/31CGL or similar (see page 20-6).

Dual-voltage relay



LVM30...

Order code	Auxiliary supply voltage	Type of output contact	Qty per pack	Wt
	[V] 50/60Hz	$\frac{C}{O}$	n°	[kg]

Emptying or filling functions.
Automatic reset.

LVM30A240	24/220...240VAC	2 C/O (SPDT)	1	0.315
LVM30A415	110...127VAC 380...415VAC	2 C/O (SPDT)	1	0.315

Operational characteristics

- Used with 3 sensing electrodes, MIN, MAX and COM
- 2.5...50k Ω adjustable sensitivity
- Programming selector for emptying or filling function with fail-safe operation
- Double insulation between each supply, electrodes and output relay circuits
- Adjustable probe signal delay: 1...10s or pump start delay: 0...300s
- Green LED indicator for power on
- Red LED indicator for output relay state
- Modular DIN 43880 housing (3 modules)
- IEC degree of protection: IP40 on front (only when mounted in housing or electric board with IP40); IP20 on terminals.

Certifications and compliance

Certifications obtained: UL Listed, for USA and Canada (cULus-File E93601), as Auxiliary Devices - Level control relays, EAC.

Compliant with standards: IEC/EN/BS 60255-27, IEC/EN/BS 61000-6-2, IEC/EN/BS 61000-6-3, UL508, CSA C22.2 n° 14.

Probes and electrode holders

Use probes and electrode holders type:

11SN1/31PS31/31PS3S/31SCM/31CGL or similar (see page 20-6).

Single-voltage multifunction relay



LVM40...

FUNCTIONS

A- Emptying with MIN and/or MAX alarms.

B- Filling with MIN and/or MAX alarms.

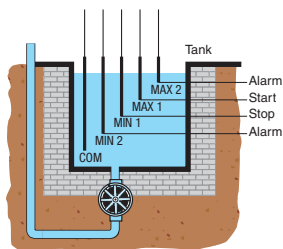

EXAMPLE OF EMPTYING OPERATION

To achieve this type of operation, two electrodes are used to control the liquid between the fixed limits using MIN1 and MAX1 and two alarm levels using MIN2 and MAX2. When one of the alarm electrodes is wet, the alarm relay is de-energised. The alarm can be caused by pump malfunction, insufficient pump delivery capacity, MAX control level failure or MIN level electrode shorted. With a proper connection, only the MIN alarm or MAX alarm can be activated or neither of the two can be activated so the relative output contacts can be used for pump control.

C- Emptying with pump priority change.

D- Filling with pump priority change.

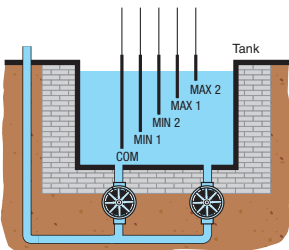

EXAMPLE OF EMPTYING OPERATION

This operation is obtained by using four electrodes positioned at four different levels and two relay outputs to control two pumps. For example, one can place the four electrodes, MIN1, MIN2, MAX1 and MAX2, in increasing order from the lowest to the highest levels and must control the tank emptying. Usually the level is controlled between the MIN1 and MAX1 levels by starting one of the two pumps. This case is different so the pumps can be maintained at the best efficiency and optimise their wear. When the liquid wets the MAX2 level and because the first pump is faulty or else a higher delivery capacity is needed, the second stand-by pump is activated to back up the first pump. When the liquid lowers and no longer wets the MIN2 level, the second pump is stopped and then when the MIN1 level is no longer wet, the first pump is stopped too.

E- Tank filling and well drawing with alarm.

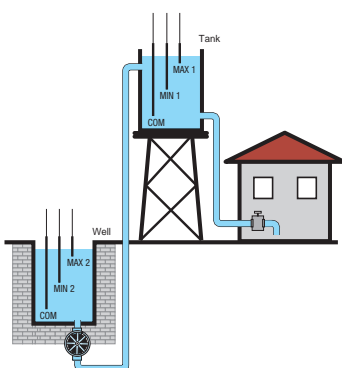

EXAMPLE

Two electrodes are used in this operation to control the tank level and another two for the well. One relay is used to activate the pump while the other for dry running / no water alarm. When the well liquid wets the MAX2 level and the liquid wets the MIN1 tank level, the tank-filling pump is activated. When the tank MAX1 level is wet, the pump is stopped. During the tank filling, the pump could stop before the MAX1 level is wet because the well MIN2 level is no longer wet. Should the tank MIN1 level no longer be wet at which the pump should restart but the well MIN2 level is also no longer wet, then the alarm relay is de-energised.

Order code	Auxiliary supply voltage	Type of output contacts	Qty per pack	Weight
	[V] 50/60Hz	①	n°	[kg]
Multifunction Automatic reset.				
LVM40A024	24VAC	1+1NO	1	0.278
LVM40A127	110...127VAC	1+1NO	1	0.278
LVM40A240	220...240VAC	1+1NO	1	0.278
LVM40A415	380...415VAC	1+1NO	1	0.278

① Two relay outputs: one with C/O (SPDT) and one with N/O (SPST).

Operational characteristics

- Use with 5 sensing electrodes, MIN1, MAX1, MIN2, MAX2 and COM
- 2.5...200kΩ adjustable sensitivity
- Adjustable sensitivity full-scale value: 25-50-100-200kΩ
- Separate sensitivity adjustment of MAX electrodes for foam detection
- Insensitivity to stray electrode-cable capacitance
- Programming selector for 5 different functions:
 - Emptying function and alarms (pos. A)
 - Filling function and alarms (pos. B)
 - Emptying function with pump priority start-up change (pos. C)
 - Filling function with pump priority start-up change (pos. D)
 - Well draining and tank filling and alarms (pos. E)
- Double insulation between each supply, electrodes and output relay circuits
- Adjustable probe signal delay: 1...10s
- Adjustable pump start delay: 0...30min
- Green LED indicator for power on
- Red LED indicators for output relay and electrode state
- Modular DIN 43880 housing (3 modules)
- IEC degree of protection: IP40 on front (only when mounted in housing or electric board with IP40); IP20 on terminals.

Certifications and compliance

Certifications obtained: UL Listed, for USA and Canada (cULus-File E93601), as Auxiliary Devices - Level control relays, EAC. Compliant with standards: IEC/EN/BS 60255-27, IEC/EN/BS 61000-6-2, IEC/EN/BS 61000-6-3, UL508, CSA C22.2 n° 14.

Probes and electrode holders

Use probes and electrode holders type: 11SN1/31PS31/31PS3S/31SCM/31CGL or similar (see page 20-6).

Single-voltage relay



31LV1E...

Order code	Auxiliary supply voltage	Type of output contact	Qty per pack	Wt
	[V] 50/60Hz	1	n°	[kg]

Emptying function.
Automatic reset.

31LV1E24	24VAC	1 C/O (SPDT)	1	0.263
31LV1E110	110...120VAC	1 C/O (SPDT)	1	0.263
31LV1E230	220...240VAC	1 C/O (SPDT)	1	0.263
31LV1E400	380...415VAC	1 C/O (SPDT)	1	0.263

Operational characteristics

- Used with 3 sensing electrodes, MIN, MAX and COM
- 7...8kΩ fixed sensitivity
- Red LED indicator for output relay state
- Max. relay-electrode cable length: 500m/547yd single-core, double insulated cables
- Mounting on 35mm/1.38" (IEC/EN/BS 60715) DIN rail or 8-pin plug-in housing
- 8-pin plug-in housing (socket 31S8, see page 20-9)
- IEC degree of protection: IP30.

Certifications and compliance

Certifications obtained: EAC.
Compliant with standards: IEC/EN/BS 60255-27.

Probes and electrode holders

Use probes and electrode holders type: 11SN1/31PS31/31PS3S/31SCM/31CGL or similar (see page 20-6).

Dual-voltage relay



31LV2E...

Order code	Auxiliary supply voltage	Type of output contact	Qty per pack	Wt
	[V] 50/60Hz	1	n°	[kg]

Emptying function.
Automatic reset.

31LV2E48	24/48VAC	1 C/O (SPDT)	1	0.266
31LV2E220	110...120VAC/ 220...240VAC	1 C/O (SPDT)	1	0.266
31LV2E400	220...240VAC/ 380...415VAC	1 C/O (SPDT)	1	0.266

Operational characteristics

- Used with 3 sensing electrodes, MIN, MAX and COM
- 7...8kΩ fixed sensitivity
- Red LED indicator for output relay state
- Max. relay-electrode cable length: 500m/547yd single-core, double insulated cables
- Mounting on 35mm/1.38" (IEC/EN/BS 60715) DIN rail or 11-pin plug-in housing
- 11-pin plug-in housing (socket 31S11, see page 20-9)
- IEC degree of protection: IP30.

Certifications and compliance

Certifications obtained: EAC.
Compliant with standards: IEC/EN/BS 60255-27.

Probes and electrode holders

Use probes and electrode holders type: 11SN1/31PS31/31PS3S/31SCM/31CGL or similar (see page 20-6).

Probes and electrode holders



11SN1



31SCM...



31CGL125...



31PS31



31PS3S

Electrodes



31ASTA...

Order code	Probe included	Probe length [mm/in]	Qty per pack n°	Weight [kg]
Single pole electrodes.				
11SN1	Yes	1000/39.9"	10	0.050
31SCM04	Yes	43/1.7"	1	0.060
31SCM50	Yes	500/19.7"	1	0.115
31SCM100	Yes	1000/39.4"	1	0.162
31CGL1253	Yes	327/12.9"	1	0.126
31CGL1255	Yes	500/19.7"	1	0.158
31CGL1257	Yes	700/27.6"	1	0.208
31CGL12510	Yes	1000/39.4"	1	0.281
Three pole electrode.				
31PS31	Yes	300/11.8"	1	0.120
Electrode holder (for 3 rod probes).				
31PS3S	No	—	1	0.184

① Total electrode length.

General characteristics

11SN1 SINGLE POLE PROBES

A single pole probe used for level control in wells or storage tanks. It comprises of an AISI 303 stainless steel electrode, a plastic (PPOX) holder and a cable gland.

A seal ring and the tightening of the cable gland PG7 prevent water from entering the cable terminal connector and causing its oxidation.

Cable connection: screw.

The external cable diameter must be 2.5 to 6mm/Ø0.1 to 0.24" to warrant perfect sealing.

Maximum connection cable section: 2.5mm²

Maximum operating temperature: +60°C.

Application: tanks and deep wells.

31SCM... PROBES

A single pole probe used for level control on boilers, autoclaves and in general where pressure (10bar maximum) and high temperature (+100°C maximum) are present. It comprises of an AISI 303 stainless steel electrode embedded in an aluminium oxide body and a 3/8" GAS threaded metal support holder.

Cable connection: threaded rod with nut.

Application: tanks, pressurised tanks and boilers.

31CGL125... PROBES

A single pole probe with AISI 302 electrode, used for level control on boilers and autoclaves and in general wherever pressure is maximum up to 10bar.

Maximum operating temperature: +180°C.

Threaded coupling: 3/8" GAS.

Cable connection: threaded rod with nut.

Application: tanks, pressurised tanks and boilers.

31PS31 PROBE

A small electrode holder, complete with three AISI 304 stainless steel probes.

Particularly suited to small containers whenever pressure is maximum up to 2bar.

Maximum operating temperature: +70°C.

Threaded coupling: 1/2" GAS.

Faston termination; related lugs supplied.

Application: tanks and automatic dispensers.

31PS3S ELECTRODE HOLDER

A thermoset resin electrode holder to be used with three probes (rods probes to be ordered separately) and complete with terminal cover.

Maximum operating temperature: +100°C.

2" GAS threaded coupling.

Cable connection: screw.

Application: tanks.

Certification and compliance

Certification obtained: EAC.

Compliant with standards: IEC/EN/BS 60255-27.

General characteristics

Stainless steel AISI 304 electrodes with 4M or 6M threaded extremity suitable as extensions for 31SCM... probe or as rod probe for 31PS3S electrode holder.

For connecting 31SCM... probes with electrode extension unit (31ASTA...MM4), see page 20-9.

Certification

Certification obtained: EAC.

Order code	Rod probe length [mm/in]	Qty per pack n°	Weight [kg]
For 31SCM... probes.			
31ASTA460MM4	460/18.11"	1	0.053
31ASTA960MM4	960/37.8"	1	0.103
For 31PS3S electrode holder.			
31ASTA460MM6	460/18.11"	1	0.100
31ASTA960MM6	960/37.8"	1	0.210

For grey water



Order code	Cable material	Cable length	Counterweight included	Qty	Wt
		[m]		n°	[kg]
LVFSP1W03	PVC	3	Yes	1	0.610
LVFSP1W05	PVC	5	Yes	1	0.830
LVFSP1W10	PVC	10	Yes	1	1.410
LVFSP1W15	PVC	15	Yes	1	1.930
LVFSP1W20	PVC	20	Yes	1	2.380
LVFSN1W03	Neoprene	3	Yes	1	0.640
LVFSN1W05	Neoprene	5	Yes	1	0.880
LVFSN1W10	Neoprene	10	Yes	1	1.510
LVFSN1W15	Neoprene	15	Yes	1	2.080
LVFSN1W20	Neoprene	20	Yes	1	2.480

Filling function

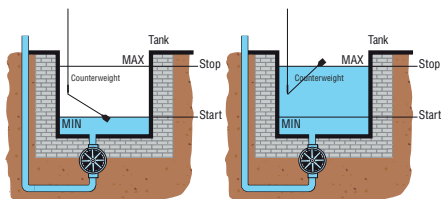

This function is achieved by connecting the black and blue float terminals. The level regulator contact closes the lower circuit at minimum level and opens the circuit when the float reaches the upper maximum level. The MIN and MAX levels can be adjusted by varying the distance between counterweight and float.

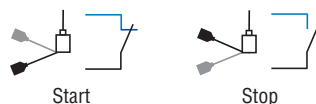

Emptying function

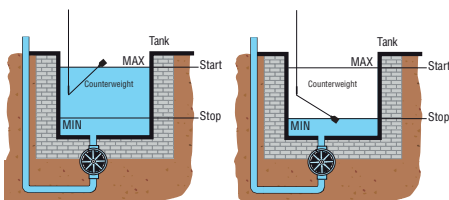

This function is achieved by connecting the black and brown float terminals. The level regulator contact closes the upper circuit at maximum level and opens the circuit when the float reaches the lower minimum level. The MIN and MAX levels can be adjusted by varying the distance between counterweight and float.

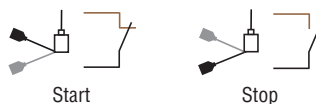

General characteristics

Float switches are used in the automation of electrical equipment, such as: pumps, solenoid valves, alarms, motorised sluice gates, etc. All versions feature an internal changeover contact operated in accordance with the level of liquid where the float is located. The cables used are high-quality and offer excellent mechanical or chemical resistance over time. The cables are 3x1 type, that is 3 wires with section 1mm². This allows the user to choose the filling and emptying function during regulator wiring. They are used for the civil and industrial control of levels of grey water, e.g. rainwater, groundwater or cooling water from industry. They are available with PVC and neoprene cables of various lengths.

Operational characteristics

- Upper switching angle: 30° ±5°
- Lower switching angle: 30° ±5°
- 130g external counterweight included
- Float casing material: polypropylene
- Cable A05 VV-F3X1 (PVC) available in lengths of 3, 5, 10, 15 and 20m/3.28, 5.47, 10.94, 16.40 and 21.87yd and cable H07 RN-F3X1 (Neoprene) available in lengths of 3, 5, 10, 15 and 20m/3.28, 5.47, 10.94, 16.40 and 21.87yd
- Rated cable diameter: 9mm/0.35" (PVC and Neoprene)
- Relay with changeover contact 10(8)A 250VAC 50/60Hz
- Maximum installation depth: 20m/21.26yd
- Maximum pressure: 2bar
- Operating temperature: 0...+50°C
- Storage temperature: -20...+80°C
- IEC degree of protection: IP68
- Insulation class: II.

Certifications and compliance

Certifications: TÜV-SUD.
Compliant with standards: IEC/EN/BS 60730-1, IEC/EN/BS 60730-2-15.

For drinking water



LVFSA1D...

Order code	Cable material	Cable length	Counter-weight included	Qty	Wt
		[m]		n°	[kg]
LVFSA1D03	PVC ACS+AD8	3	Yes	1	0.630
LVFSA1D05	PVC ACS+AD8	5	Yes	1	0.850
LVFSA1D10	PVC ACS+AD8	10	Yes	1	1.430
LVFSA1D15	PVC ACS+AD8	15	Yes	1	1.950
LVFSA1D20	PVC ACS+AD8	20	Yes	1	2.400

Filling function

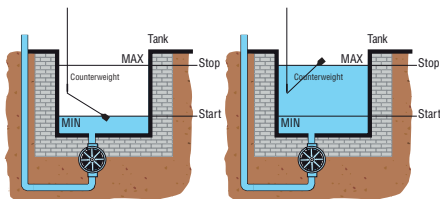

This function is achieved by connecting the black and blue float terminals. The level regulator contact closes the lower circuit at minimum level and opens the circuit when the float reaches the upper maximum level. The MIN and MAX levels can be adjusted by varying the distance between counterweight and float.



Emptying function

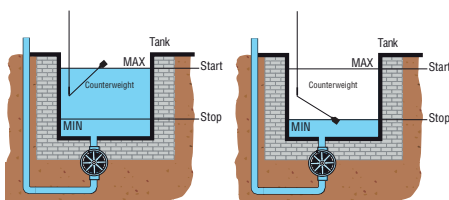

This function is achieved by connecting the black and brown float terminals. The level regulator contact closes the upper circuit at maximum level and opens the circuit when the float reaches the lower minimum level. The MIN and MAX levels can be adjusted by varying the distance between counterweight and float.

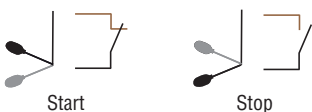

For dirty water



Filling function

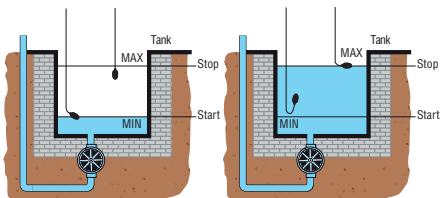

This function uses two floats and is achieved by connecting the black and blue float terminals. The MIN and MAX levels can be adjusted by varying the position of the floats.

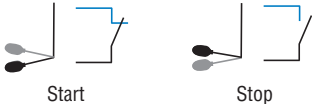

Emptying function

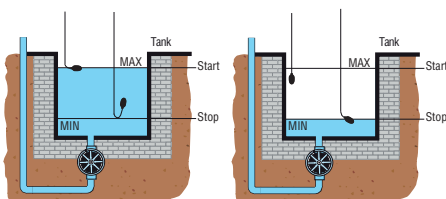

This function uses two floats and is achieved by connecting the black and brown float terminals. The MIN and MAX levels can be adjusted by varying the position of the floats.

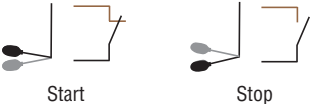

It is possible to use even a single float for black water, adjusting the level in a fixed range of 10cm max, a solution which is not advisable for turbulent waters.

General characteristics

Float switches LVFSA AT D type are suitable for drinking water and foodstuffs applications such as aqueducts, fountains, aquariums, drinks, fish hatcheries, swimming pools, etc. They are realised with a non-toxic polypropylene outer shell, a stainless steel untreated sphere, and an AD8 cable with health certification ACS (Attestation de Conformité Sanitaire) with outer sheath with PVC suitable for drinkable water immersion and use with food products. They are provided with stainless steel counter weight AISI 316. All versions, which differ in the length of the cable, feature an internal changeover contact operated in accordance with the level of liquid where the float is located. The cables are 3x1 type, that is 3 wires with section 1mm². This allows the user to choose the filling and emptying function during regulator wiring.

Operational characteristics

- Upper switching angle: 30° ±5°
- Lower switching angle: 30° ±5°
- Stainless steel counterweight AISI 316 included
- Float casing material: polypropylene
- PVC cable ACS + AD8 certified
- Microswitch with changeover contact: 10(8)A 250VAC 50-60Hz
- Maximum installation depth: 20m/21.87yd
- Maximum pressure: 2bar
- Operating temperature: 0...+50°C
- Storage temperature: -20...+80°C
- Degree of protection: IP68
- Insulation class: II.

Certifications and compliance

Certifications: Health certification ACS (Attestation de Conformité Sanitaire) for the cable. Compliant with standards: IEC/EN/BS 60730-1, IEC/EN/BS 60730-2-15.

General characteristics

These float switches are used for the civil and industrial control of levels of dirty water, e.g. sewage or waste water from industry. The float switches comprises of a one-piece external blow-moulded polypropylene casing, with fixed internal counterweight located in the cable exit area. The regulator contact is positioned centrally in its own watertight chamber. This is insulated from the external casing by injecting closed-cell foam. This solution further increases protection against moisture leakage and heat insulates the watertight chamber housing the contact, eliminating the creation of condensation.

Operational characteristics

- Upper switching angle: 30° ±5°
- Lower switching angle: 20° ±5°
- Internal counterweight
- Float casing material: polypropylene
- Cable H07 RN-F3X1 (Neoprene) available in lengths of 5, 10, 15 and 20m/5.47, 10.94, 16.40 and 21.87yd
- Rated cable diameter: 9mm/0.35"
- Relay with changeover contact 10(4)A 250VAC 50/60Hz
- Maximum installation depth: 100m/109.36yd
- Maximum pressure: 10bar
- Operating temperature: 0...+40°C
- Storage temperature: -20...+80°C
- IEC degree of protection: IP68
- Insulation class: II.

Certifications and compliance

Certifications: TÜV-SUD. Compliant with standards: IEC/EN/BS 60730-1, IEC/EN/BS 60730-2-15.



Modular version



LVMP05



LVMP10...

Order code	Auxiliary supply voltage	Type of output contacts	Qty per pack	Weight
	[V]	↘	n°	[kg]
2 outputs. AC and DC supply voltage.				
LVMP05	24/48VDC 24...240VAC	2NO with same common	1	0.090
2 outputs. AC supply voltage. Possible starting of stand-by motor.				
LVMP10A024	24VAC	2 NO (SPST)	1	0.250
LVMP10A127	110...127VAC	2 NO (SPST)	1	0.250
LVMP10A240	220...240VAC	2 NO (SPST)	1	0.250
LVMP10A415	380...415VAC	2 NO (SPST)	1	0.250

General characteristics

Priority change relays are designed to balance the operating time and hence the wear of pumps, compressors, generators, when two units, primary and stand-by, are installed.

Operational characteristics

- Operating limits: 0.85...1.1 U_e
- Connection: permanent
- Green LED indicator for power on
- Red LED indicators for output relay state 1 for LVMP05, 2 for LVMP10
- Modular DIN 43880 housing (1 module LVMP05, 3 modules LVMP10)
- IEC degree of protection: IP40 on front (only when mounted in housing or electric board with IP40); IP20 on terminals.

Certifications and compliance

Certifications obtained: UL Listed, for USA and Canada (cULus-File E93601), as Auxiliary Devices - Automatic starting control, EAC.

Compliant with standards: IEC/EN/BS 60255-27, IEC/EN/BS 61000-6-2, IEC/EN/BS 61000-6-3, UL508, CSA C22.2 n° 14.

Plug-in version



31CSP2E...

Order code	Auxiliary supply voltage	Type of output contacts	Qty per pack	Weight
	[V] 50/60Hz	↘	n°	[kg]
2 outputs. AC supply voltage. Possible starting of stand-by motor.				
31CSP2E24	24VAC	2 NO (SPST)	1	0.150
31CSP2E110	110VAC	2 NO (SPST)	1	0.150
31CSP2E220	220VAC	2 NO (SPST)	1	0.150
31CSP2E230	230...240VAC	2 NO (SPST)	1	0.150

General characteristics

Priority change relays are designed to balance the operating time, and hence the wear of pumps, compressors, generators, when two units, primary and stand-by, are installed.

Operational characteristics

- Operating limits: 0.85...1.1 U_e
- Connection: permanent
- Voltage applied to input contacts: 15VDC not insulated at power supply
- Input contacts current consumption: about 1mA.
- 11-pin plug-in housing (see socket 31S11).
- IEC degree of protection: IP30.

Certifications and compliance

Certifications obtained: EAC.

Compliant with standards: IEC/EN/BS 60255-27, IEC/EN/BS 61000-6-2, IEC/EN/BS 61000-6-3.

Accessories



31RE213



31S8



31S11



31RE014

Order code	Description	Qty per pack	Weight
		n°	[kg]
31RE213	Coupler unit for 31SCM... with electrode extension ASTA...MM4	1	0.008
31S8	8-pin socket for screw fixing or mounting on 35mm/1.38" DIN rail (IEC/EN/BS 60715), used with LV1E... relay. Screw terminals	10	0.061
31S11	11-pin socket for screw fixing or mounting on 35mm/1.38" DIN rail (IEC/EN/BS 60715), used with LV2E... and CSP2E... relays. Screw terminals	10	0.064
31RE014	Relay-socket retention bracket; 31S8 or 31S11 types only	10	0.001

Operational characteristics

SOCKETS FOR INSTALLING PLUG-IN LEVEL CONTROL RELAYS.

- Max. wire section for sockets: 2x2.5mm²/2x14AWG
- Tightening torque: 0.8Nm/7.1lb.in
- Ratings: 10A - 400VAC.

Certifications and compliance

Certifications obtained: EAC.

Compliant with standards: IEC/EN/BS 61984, IEC/EN/BS 61210, IEC/EN/BS 60999-1.

LEVEL CONTROL AND START-UP PRIORITY CHANGE RELAYS

LVM25... - LVMP05

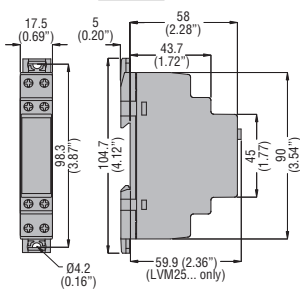

LVM20...

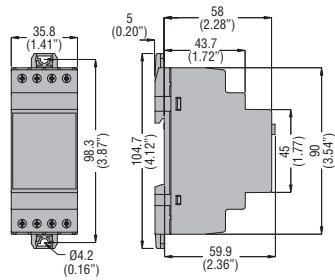

LVM30... - LVM40... - LVMP10

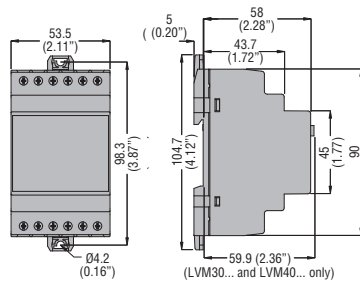

31LV1E... - 31LV2E... - 31CSP2E...

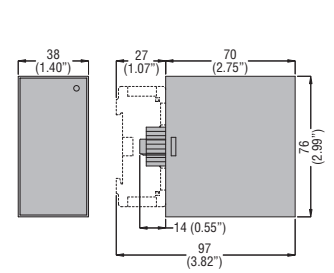

PROBES AND ELECTRODE HOLDERS FOR CONDUCTIVE LIQUIDS

11SN1

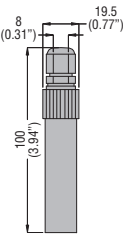

31SCM...

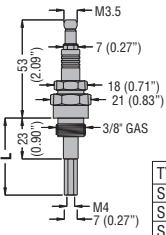

TYPE	L
SCM04	43 (1.69")
SCM50	500 (19.68")
SCM100	1000 (39.37")

31CGL125...

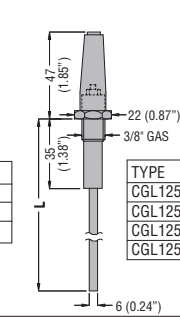

TYPE	L
CGL1253	327 (12.87")
CGL1255	500 (19.68")
CGL1257	700 (27.56")
CGL12510	1000 (39.37")

31PS31

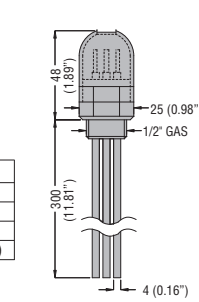

31PS3S

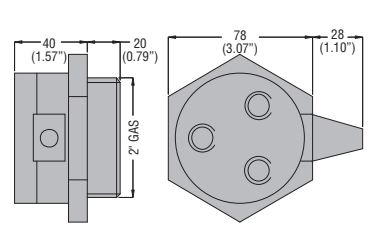

ELECTRODES

31ASTA460MM4 31ASTA960MM4

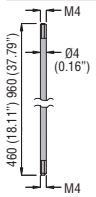

31ASTA460MM6 31ASTA960MM6

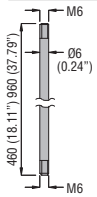

Coupler unit

31RE213

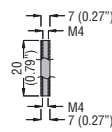

FLOAT SWITCHES

LVFS...W... LVFS...D...

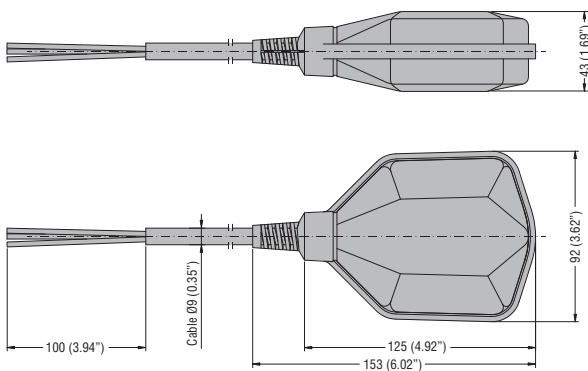

LVFSN1B...

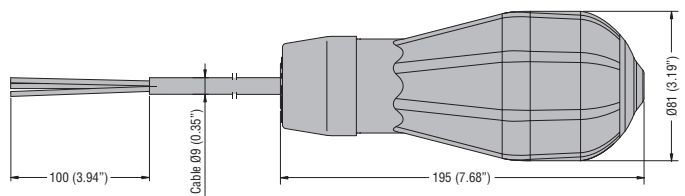

ACCESSORIES

31S8 - 31S11

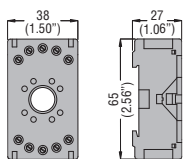

31RE014

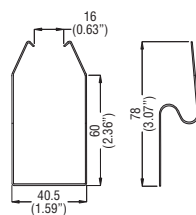

Emptying function

LVM20

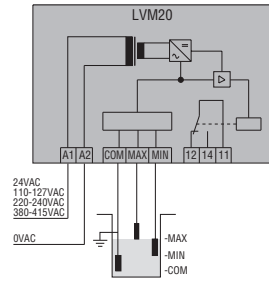

Emptying function with 3 electrodes

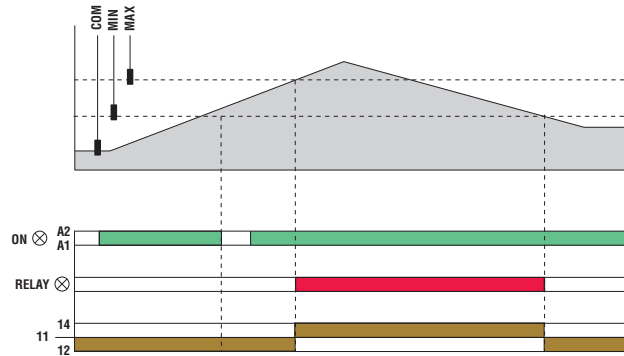

Emptying function with 2 electrodes

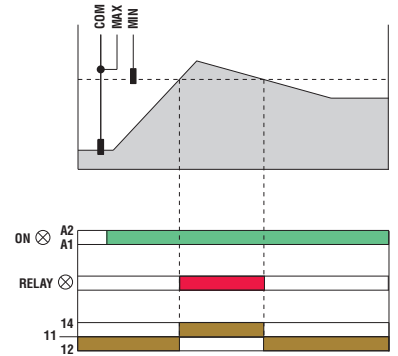

Emptying or filling functions

LVM25

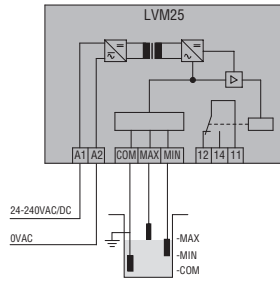

Emptying function (DOWN)

Connection with 3 electrodes

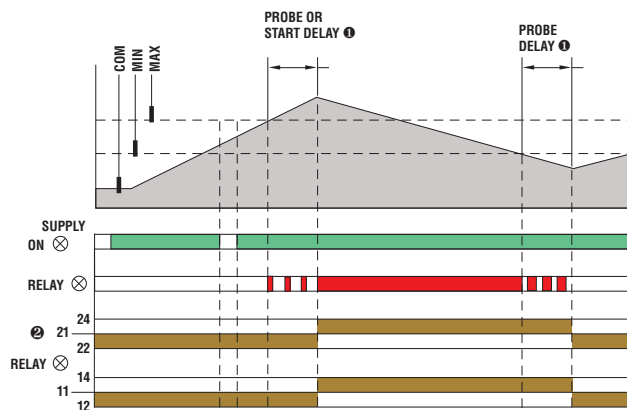

Connection with 2 electrodes

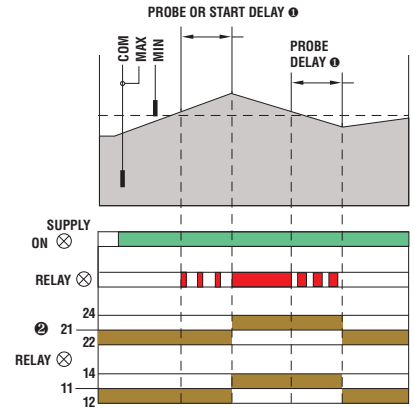

LVM30

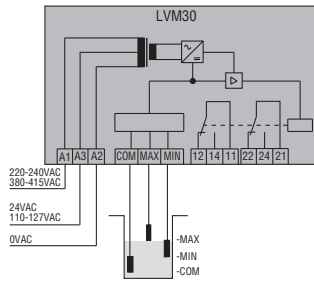

Filling function (UP)

Connection with 3 electrodes

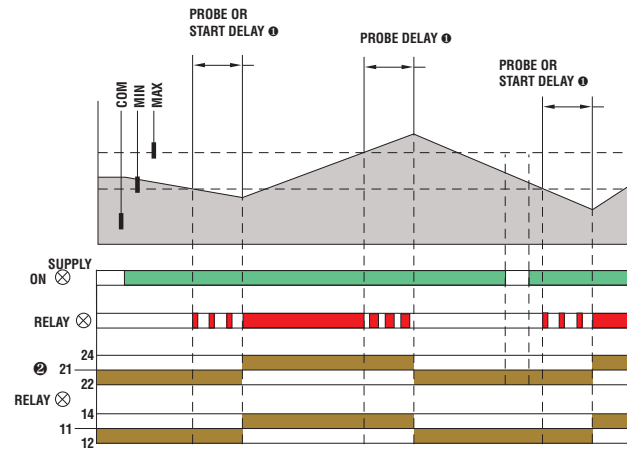

Connection with 2 electrodes

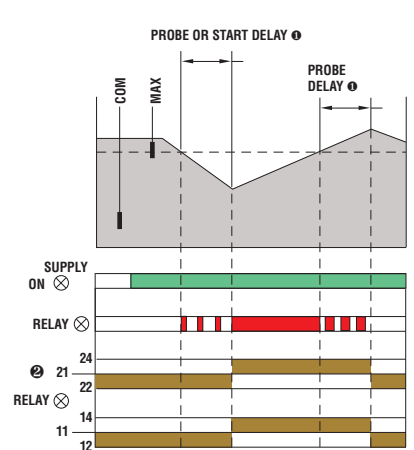

① Delay for LVM30 only.
 ② Changeover contact (SPDT) for LVM30 only.

Multifunctions.
LVM40

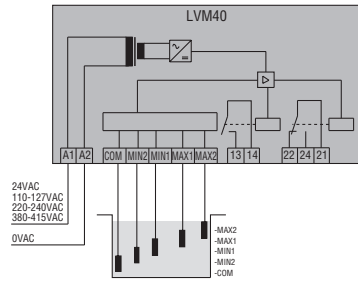

Emptying function + alarms

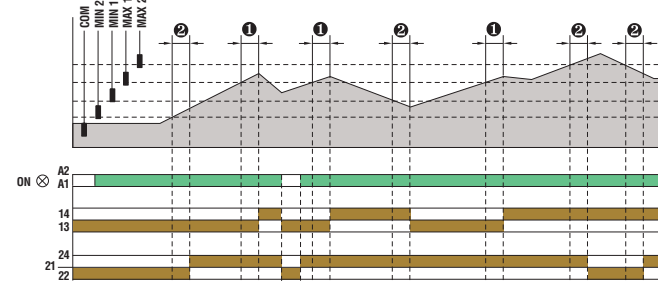

Filling function + alarms

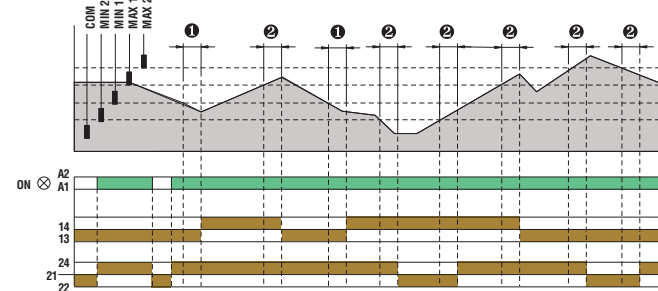

Emptying function + pump change

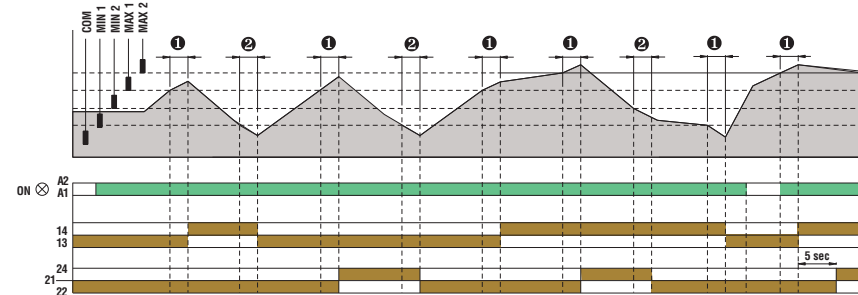

Filling function + pump change

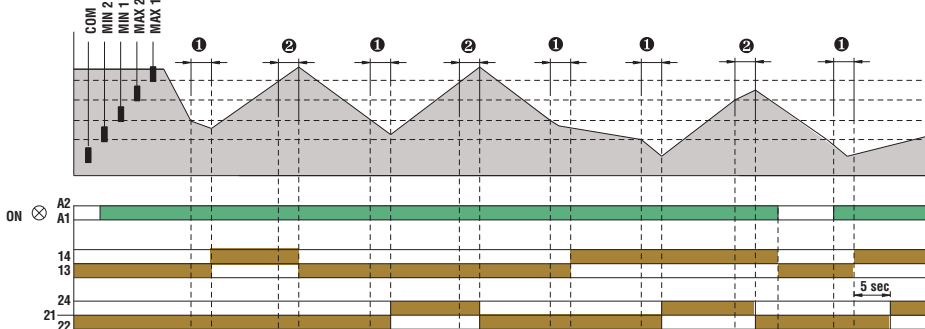

Filling tank and draining well function + alarm

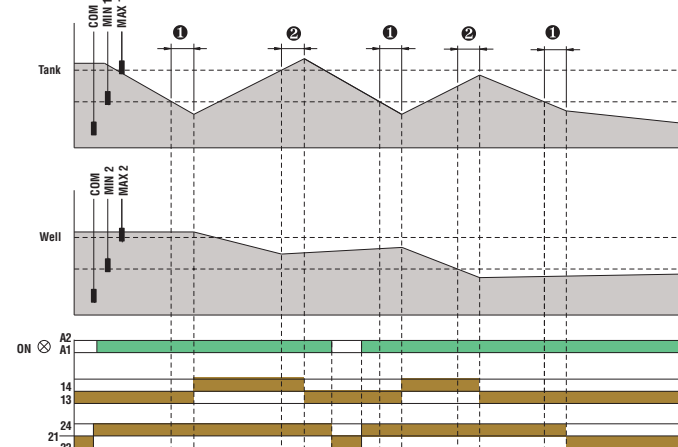

- ① Probe delay + start delay.
- ② Probe delay.

Emptying function

31LV1E

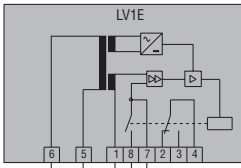

31LV2E

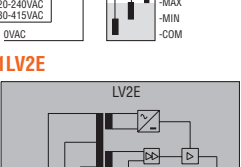

Emptying function with 3 electrodes

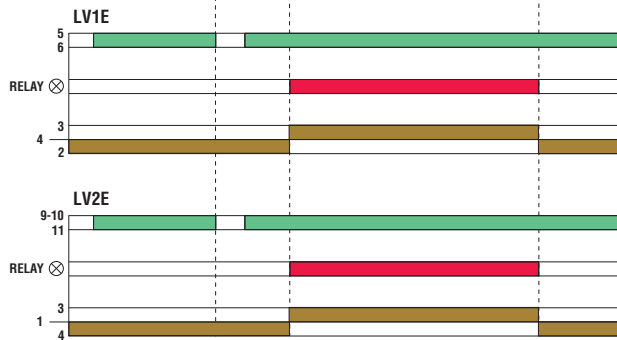
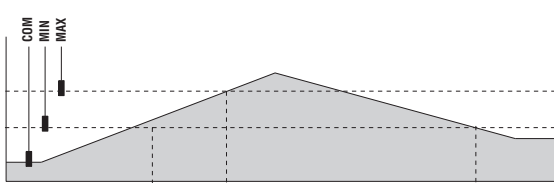

Emptying function with 2 electrodes

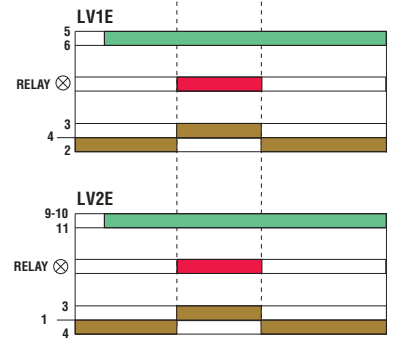
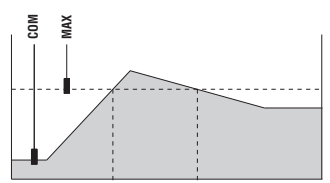

Priority change relays

LVMP05

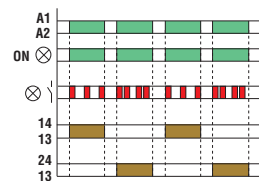
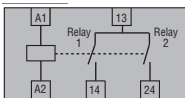

LVMP10

2-wire connection

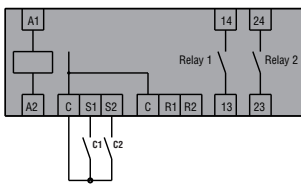

C1 = Primary
C2 = Secondary / Standby

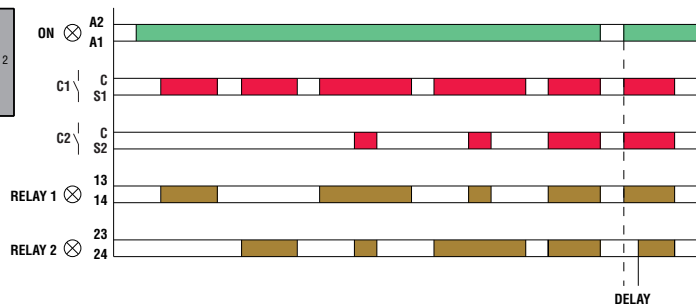

3-wire connection

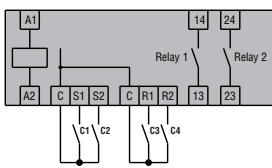

C1 = Start Primary
C2 = Start Standby
C3 = Stop Primary
C4 = Stop Standby

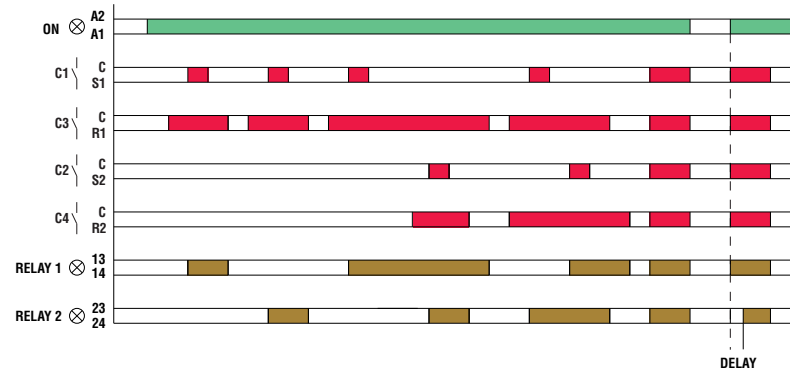

31CSP2E

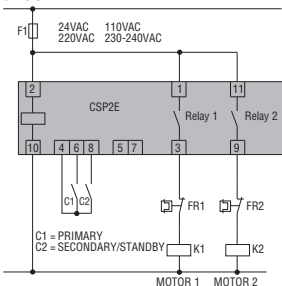

C1 = PRIMARY
C2 = SECONDARY/STANDBY

TYPE	LVM20...	LVM25...	LVM30...	LVM40...
DESCRIPTION	Modular Automatic reset			
Application (examples)	Single voltage Emptying function	Multi voltage Emptying or filling function	Dual voltage Emptying or filling function	Single voltage Multifunctions
Operating principle	Electrical conductivity of liquids			
AUXILIARY SUPPLY				
Rated supply voltage Us	24VAC 110...127VAC 220...240VAC 380...415VAC	24...240VAC/DC	24/220...240VAC 110...127/380...415VAC	24VAC 110...127VAC 220...240VAC 380...415VAC
Operating voltage range	0.85...1.1 Us; 50/60Hz ±5%			
Power consumption (maximum)	3.5VA	3VA	5.5VA	4.5VA
Power dissipation (maximum)	1.8W	1.2W	2.8W	2.8W
LEVEL ELECTRODES				
Number of connectable electrodes	3	3	3	5
Type of electrode	Electrode and electrode holders: SN1 / SCM / CGL / PS31 / PS3S or similar			
Electrode voltage	7.5VAC	10Vpp	7.5VAC	10Vpp
Sensitivity	2.5...50kΩ	2.5...100kΩ	2.5...50kΩ	2.5...200kΩ
TIME DELAYS				
Tripping time (minimum)	≤ 600ms	≤ 1s	1s	1s
Resetting time (minimum)	≤ 750ms	≤ 1s	1s	1s
Probe tripping delay	—	—	OFF...10s	1...10s
Relay energising delay	—	—	OFF...300s	0...30min
RELAY OUTPUTS				
Number of relays	1	1	2	2
Relay state	Normally de-energised, energises at tripping			
Contact arrangement	1 changeover / SPDT	1 changeover / SPDT	2 changeover / SPDT each	1 changeover / SPDT and 1 with 1 N/O - SPST
Rated utilisation voltage	250VAC			
Maximum switching voltage	400VAC			
IEC conventional free air thermal current Ith	8A			
UL/CSA and IEC/EN/BS 60947-5-1 designation	B300			
Electrical life (with rated load)	10 ⁵ cycles			
Mechanical life	30x10 ⁶ cycles			
Indications	1 green LED for power on 1 red LED for relay state	1 green LED for power on 1 red LED for relay state	1 green LED indicator for power on 1 red LED for relay state	1 green LED indicator for power on 2 red LEDs for relay state 2 red LEDs for probe state
INSULATION				
IEC rated insulation voltage Ui	415VAC	240VAC	415VAC	415VAC
IEC rated impulse withstand voltage Uimp	6kV	4kV	6kV	6kV
IEC power frequency withstand voltage	4kV	2kV	4kV	4kV
Double insulation Supply/relay/electrode	≤ 250VAC	≤ 250VAC ^①	≤ 250VAC	≤ 250VAC
CONNECTIONS				
Tightening torque maximum	0.8Nm (7lb.in; 7-9lb.in for UL/CSA)			
Conductor section min-max	0.2...4mm ² (24...12AWG; 18...12AWG for UL/CSA)			
AMBIENT CONDITIONS				
Operating temperature	-20...+60 °C			
Storage temperature	-30...+80 °C			
HOUSING				
Material	Self-extinguishing polyamide			
Typical configuration (examples)	LVM20 + n° 3 SN1 electrodes LVM30 + n° 3 SN1 electrodes		LVM25 + n° 3 SN1 electrodes LVM40 + n° 5 SN1 electrodes	
Maximum cable length	②			

① Double insulation between supply, electrodes and output relay circuit.

② Voltage applied to input contacts, not insulated at power supply.

③ Consult Technical support for more information; see contact Tel. +39 035-4282422 - E-mail: service@LovatoElectric.com.

	31LV1E...	31LV2E...	LVMP05	LVMP10	31CSP2E
	Plug-in		Modular	Modular	Plug-in
	Automatic resetting		—	—	—
	Single voltage	Dual voltage	Multistage	Single voltage	Single voltage
	Emptying function		Priority change relay for motors		
	Electrical conductivity of liquids		—		
	24VAC 110...120VAC 220...240VAC 380...415VAC	24/48VAC 110...120VAC/220...240VAC 220...240VAC/380...415VAC	24/48VDC 24...240VAC	24VAC 110...127VAC 220...240VAC 380...415VAC	24VAC [Ⓜ] 110VAC [Ⓜ] 220VAC [Ⓜ] 230/240VAC [Ⓜ]
	0.8...1.1 Us; 50/60Hz				
	5.5VA 2.8W		1.6VA 0.9W	4.8VA 3W	5VA 3W
	3		—	—	—
	Electrode and electrode holders: SN1 / SCM / CGL / PS31 / PS3S / or similar		—	—	—
	9VAC (voltage between probes)		—	—	—
	7...8 kΩ fixed		—	—	—
	≤ 50ms		—	—	—
	≤ 100ms		—	—	—
	—		—	—	—
	—		—	—	—
	1		2	2	2
	Normally de-energised, energises at tripping				
	1 changeover contact / SPDT		2 N/O with same common	2 N/O - SPST	2 N/O - SPST
	220VAC 380VAC		250VAC —	250VAC —	250VAC —
	5A		8A	8A	5A
	B300		B300	B300	B300
	2.5x10 ⁵ cycles 50x10 ⁶ cycles		10 ⁵ cycles 30x10 ⁶ cycles	10 ⁵ cycles 30x10 ⁶ cycles	10 ⁵ cycles 30x10 ⁶ cycles
	1 red LED for relay state		1 green LED for power on 1 red LED for relay state	1 green LED for power on 2 red LED for relays state	1 green/red LED for relay state
	415VAC		250VAC	415VAC	250VAC
	5kV		4kV	4kV	4kV
	2kV		2kV	2.5kV	2.5kV
	—				
	—		0.8Nm (7lb.in; 7-9lb.in for UL/CSA)	—	—
	—		0.2...4.0mm ² (24...12AWG; 18...12AWG for UL/CSA)	—	—
	-20...+60°C				
	-30...+80°C				
	Self-extinguishing polycarbonate		Self-extinguishing polyamide	Self-extinguishing polyamide	Self-extinguishing polycarbonate
	LV1E + n° 3 SN1 electrode		—	—	—
	LV2E + n° 2 SN1 electrodes + reset button		—	—	—
	500m/547yd single-core, double insulated cables		—	—	—